

Technical Bulletin

Bulletin Number: 477 Revision Number: R-02
Release Date: Aug. 26, 1993 Revision Date: Sept. 23, 1993

SUBJECT: KEYED LOCKOUT SWITCH

MODELS AFFECTED: All Series 90 Venders
All MPC Venders
All Series II Venders
All Dual Adaptable - Red Cam Venders
All Adaptable - Red Cam Venders
All Adaptable - White Cam Venders

REASON:

1. To provide a way to "turn off" a vender without opening the main door or unplugging the vender.
2. To provide a way to "turn off" certain selections in a vender without opening the main door.

Bulletin Index

A.	To turn off all selections and main door power.	Page 2 & 3
B.	To turn off certain selections only. (Not used on MPC and Series II venders)	Page 4 & 5
C.	Lockout switch assembly parts.	Page 6

**INSTALLATION TO TURN OFF ALL SELECTIONS
AND POWER TO THE MAIN DOOR:**

Parts needed:

1 - 801,510,100.01	Lockout switch assembly
1 - 804,905,460.01	Lockout switch lead
1 - 804,901,950.01	Adapter - Standard socket on one end and polarized plug on the other end
1 - 804,901,960.01	Adapter - Standard plug on one end and polarized socket on the other end.
4 - 900,900,270.01	Wire tie, 6"

To install:

1. Unplug the vender.
2. Choose the location you wish to mount the lockout switch. Important: Keep in mind the lockout switch lead is about 85 inches long.
3. Drill a 25/32" hole through the door at the chosen location. Caution: Do not drill through any wiring or parts.
4. Remove the retaining nut and lock washer from the lockout switch.
5. Place lockout switch in position.
6. Install the lock washer on the lockout switch so the teeth of the washer will bite in the door metal.
7. Secure the lockout switch with the retaining nut that was removed in step number 4.
8. Locate the stack plug on the lower hinged side of the cabinet. (See figure 5, page 3.)
9. Unplug the stack plug.
10. Look at the plug and socket. Determine if they are polarized (see figure 3, page 3) or standard (non polarized) (see figure 4, page 3).
11. If polarized, go to step number 14.
12. If standard (non polarized), plug the adapter lead with the standard socket to the standard plug of the stack plug. Make sure the ribbed side of the adapter wire is plugged to meet the ribbed side of the stack plug wire.

13. If standard (non polarized), plug the adapter lead with the standard plug to the standard socket of the stack plug. Make sure the ribbed side of the adapter wire is plugged to meet the ribbed side of the stack plug wire.
14. Locate the lockout switch lead provided.
15. Plug the socket and plug ends of the lockout switch lead to the stack plug and socket.
16. Run the lockout switch lead harness to the area you installed the lockout switch in step number 5.
17. Plug the lockout switch leads to the lockout switch.
18. Secure the lockout switch lead to existing wire harness with wire ties to prevent interference with any moving parts.
19. Open and close the door to ensure the lockout switch lead does not interfere with the opening or closing of the door.
20. Plug in the vender and test for proper operation.

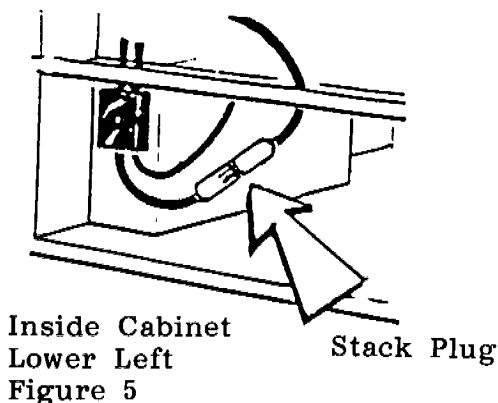
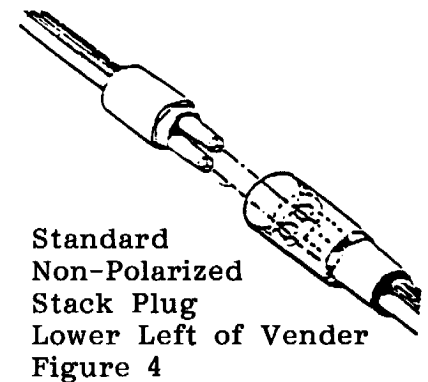
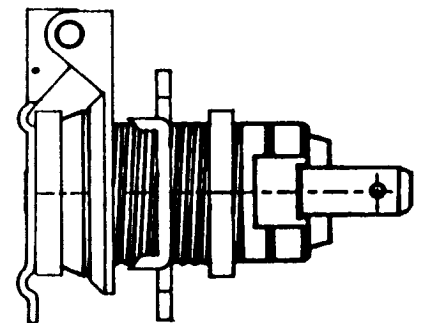
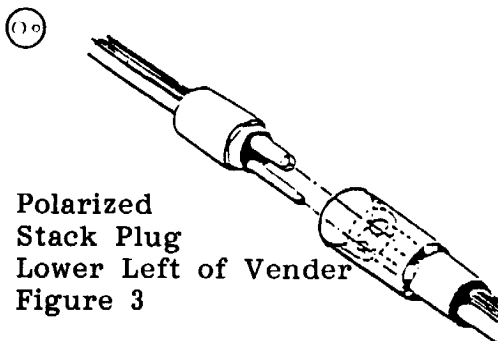
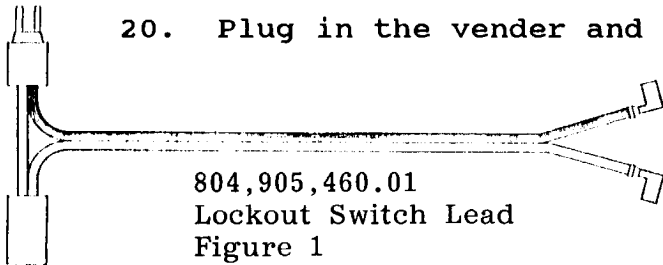

**INSTALLATION TO TURN OFF CERTAIN SELECTIONS:
(Not used on MPC and Series II venders)**

Parts needed:

1 - 801,510,100.01	Lockout switch assembly
2 - 804,906,250.01	Lock switch lead (Pepsi, Generic, all Flat Front)
2 - 804,906,260.01	Lock switch lead (Coke Landscape, B7, D3)
4 - 900,900,270.01	Wire tie, 6"

Note: The following lead is used on older lock switches that need an eyelet for installation.

2 - 804,905,440.01	Lock switch lead (see figure 8)
--------------------	---------------------------------

To install:

1. Unplug the vender.
2. Choose the location you wish to mount the lockout switch.
Important: Keep in mind the lock switch lead is about 36 inches long.
3. Drill a 25/32" hole through the door at the chosen location.
Caution: Do not drill through any wiring or parts.
4. Remove the retaining nut and lock washer from the lock out switch.
5. Place lock out switch in position.
6. Install the lock washer on the lock out switch so the teeth of the washer will bite in the door metal.
7. Secure the lockout switch with the retaining nut that was removed in step number 4.
8. Important: Identify the type of select panel you have and remember the power flow through the panel.
9. Decide which two select switches you need to wire the lock switch between.
10. Unplug the wire from the common position of the first select switch, in the sequence of power flow, that you want to turn off with the lock switch.
11. Install one end of one lock switch lead (see "A", Figures 6 & 7.) to the common position of the select switch that you unplugged the wire in step 10.

12. Install the other end of the lock switch lead (see "B", figures 6 & 7) to the lock out switch.
13. Locate the normally closed position of the select switch that feeds power to the common of the select switch affected in step 10.
14. Unplug the wire from the normally closed position of this select switch.
15. Install one end of the other lock switch lead (see "A", figures 6 & 7) to the normally closed position of the select switch that you unplugged the wire in step 14.
16. Install the other end of the lock switches lead (see "B", figures 6 & 7) to the lock out switch.
17. Secure the lock switch leads to existing wire harness with wire ties to prevent interference with any moving parts.
18. Plug in the vender and test for proper operation.

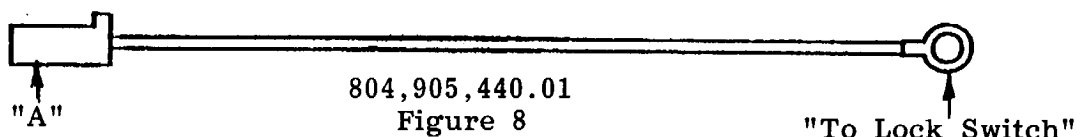
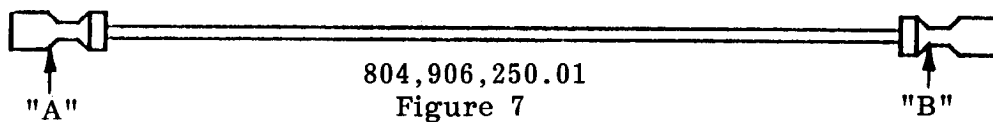
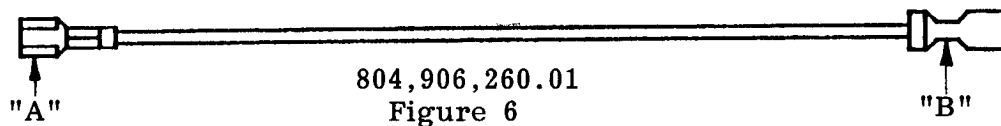

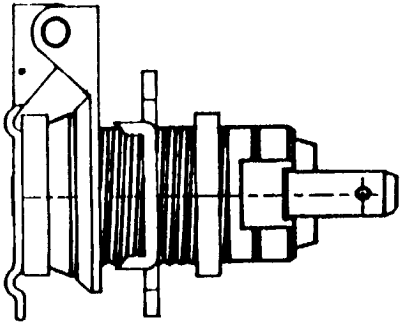

Lock-Out Assembly
B 801,510,100.01

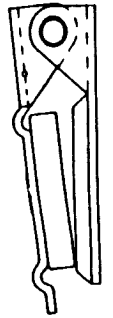
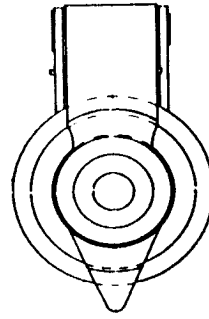

Dust Cover
A 801,510,350.01

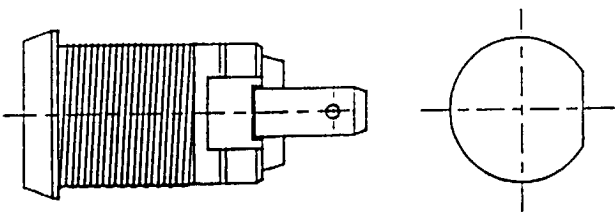

Lock-Out Switch
A 801,510,110.01

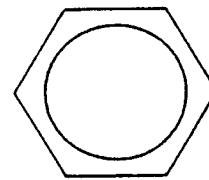

Hex Nut
A 801,510,120.01

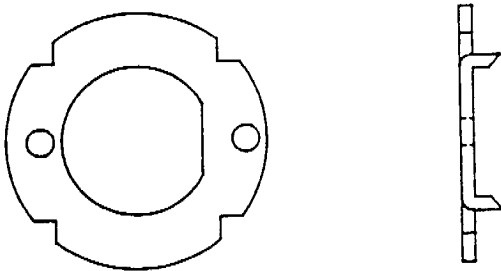

Steel 4-Prong Washer
A 801,510,130.01